

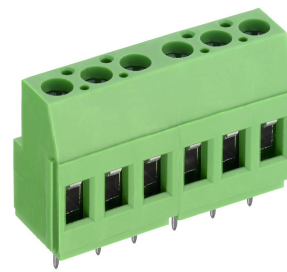





## AK700/..-5.0-V-GREEN



## Technical Data

Wire sizes		Insulating Material	
Solid min	0.2 mm <sup>2</sup>	Material	PA 6.6
Solid max	4.0 mm <sup>2</sup>	Flammability Class	UL 94 V-0
Stranded (flexible) min	0.2mm <sup>2</sup>	<b>Temperatures</b>	
Stranded (flexible) max	2.5 mm <sup>2</sup>	Operating Temperature	-30 °C - 105 °C
Stranded with Ferrule min	0.25 mm <sup>2</sup>	Store Temperature	-40 °C - 105 °C
Stranded with Ferrule max	2.5 mm <sup>2</sup>	<b>Wave Soldering Process</b>	
<b>Dimensions</b>		Soldering Temperature, recommended	265 °C
Stripped Length	8.0 mm	Peak Soldering Time, recommended	3-4 s
PCB Hole Diameter	1.3 mm	<b>Reflow Process</b>	
<b>Materials</b>		Soldering Temperature, recommended	-
Clamp	Brass	Peak Soldering Time, recommended	-
Screw	Steel		
Solder Tab	Copper Alloy		

## Colours

	GREEN, RAL 6018
	GREY, RAL 7016
	PEBBLE GREY, RAL 7032
	BLUE, RAL 5015
	LIGHT GREEN, similar RAL 6018



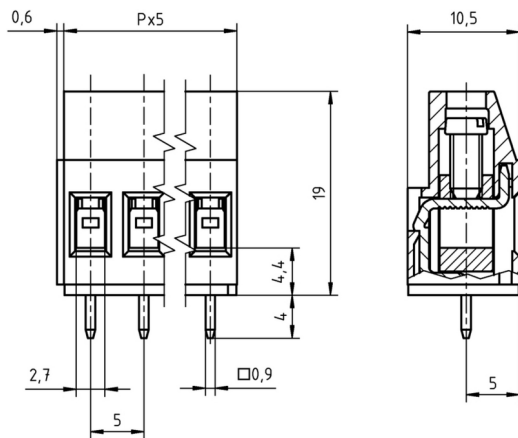

Colours according to RAL, there may be variations on colour due to production conditions. Special colours on request.



## Order Data (Spacing 5.0 mm)

Poles	Width (mm)	Article Designation	Article Number	PU
2	10.60	AK700/2-5.0-V-GREEN	50700020201 F	200
3	15.60	AK700/3-5.0-V-GREEN	50700030201 F	200
4	20.60	AK700/4-5.0-V-GREEN	50700040201 F	200
5	25.60	AK700/5-5.0-V-GREEN	50700050201 F	200
6	30.60	AK700/6-5.0-V-GREEN	50700060201 E	100
7	35.60	AK700/7-5.0-V-GREEN	50700070201 E	100
8	40.60	AK700/8-5.0-V-GREEN	50700080201 E	100
9	45.60	AK700/9-5.0-V-GREEN	50700090201 E	100
10	50.60	AK700/10-5.0-V-GREEN	50700100201 D	50
11	55.60	AK700/11-5.0-V-GREEN	50700110201 D	50
12	60.60	AK700/12-5.0-V-GREEN	50700120201 D	50

## Accessoires

Figure	Designation	Article Number
	Bridge, 2-pole, insulated, BRI/2-5.0/5.08-LIGHT GREY	Art.-Nr. 50000000006
	Bridge, 3-pole, insulated, BRI/3-5.0/5.08-LIGHT GREY	Art.-Nr. 50000000007
	Bridge, 2-pole, BR/2-5.0/5.08-L7.0	Art.-Nr. 50000000008
	Screw Cover SC-AK700-YELLOW	Art.-Nr. 50700000004

See pages 282 ff for detail and general accessories and see pages 12/13 concerning services.

## Ratings

UseGroup	cRU <sup>®</sup> US			VDE	
	B	C	D		
Rated Voltage	300 V	-	300 V	250 V	
Rated Current	20 A	-	10 A	24 A	
Rated Wire Size				min	max
	- solid	AWG 30-12	-	AWG 30-12	0.5 mm <sup>2</sup> 4.0 mm <sup>2</sup>
	- stranded	AWG 30-12	-	AWG 30-12	0.5 mm <sup>2</sup> 2.5 mm <sup>2</sup>
Torque	0.45 Nm	-	0.45 Nm	0.50 Nm	
Screw Size	M3	-	M3	M3	
Test Voltage	1.60 kV	-	1.60 kV	2.0 kV	